

Targets for nuclear physics studies

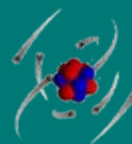

Anna Stolarz

Heavy Ion Laboratory

Nuclear reaction is a process in which two, three nuclei or nuclei and particle such as neutron, proton ... collide producing the product other than the initial 'items'.

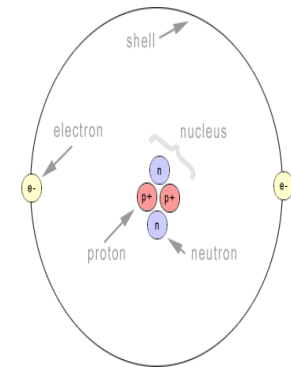

Nuclear reaction is a process in which two, three nuclei or nuclei and particle such as neutron, proton ... collide producing the product other than the initial 'items'.

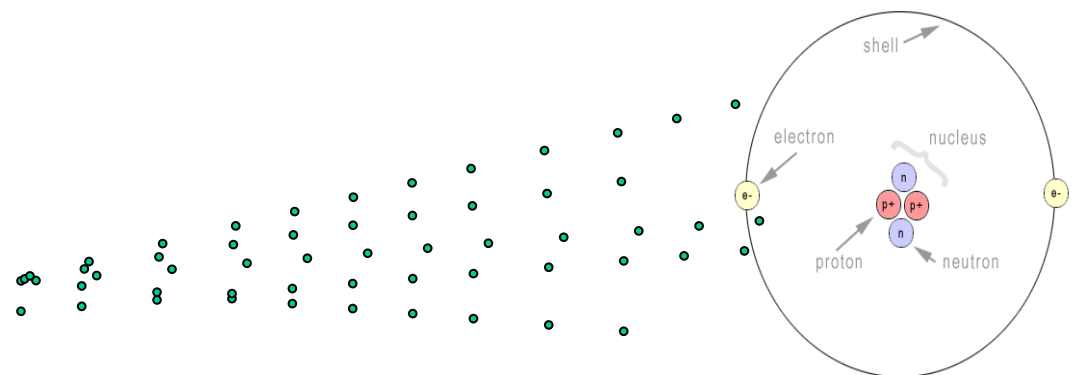

Lithium 7
(Li-7)



The first artificial nuclear reaction was performed by John Cockcroft and Ernest Walton in 1932. They bombarded the ${}^7\text{Li}$ with ‘artificially’ accelerated protons. In result the two helium nuclei (α particles) were created.

What is the target?

Gasous or liquid

- gas or liquid flow (the melted metals as well)
- material closed in the chamber kept in the low temperature
- in case of gaseous target:
implantation into the solid backing/carrier



Rutherford transmutation „An anomalous effect in nitrogen,”

the alpha particle (from Polonium), which passed through the container with nitrogen gas, and nitrogen nucleus stuck together with a proton flying loose.

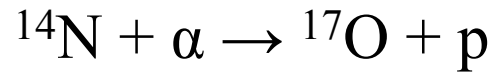

The apparatus used in 1919 by Rutherford's team for observation of the α particles interaction with light nuclei what resulted with transmutation of nitrogen into oxygen

What is the target?

Gasous or liquid

- gas or liquid flow (the melted metals as well)
- material closed in the chamber kept in the low temperature
- in case of gaseous target:
implantation into the solid backing/carrier

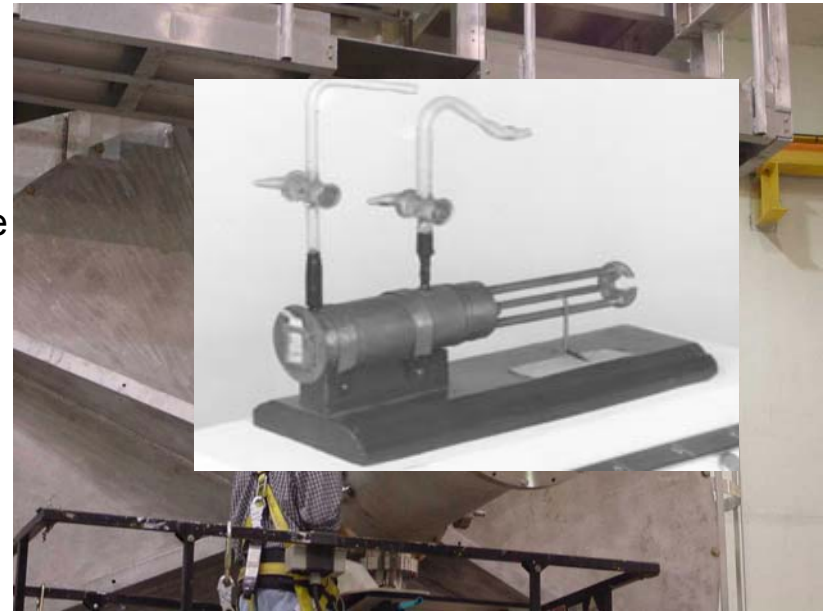

Solid targets

- self supporting
- on the backing

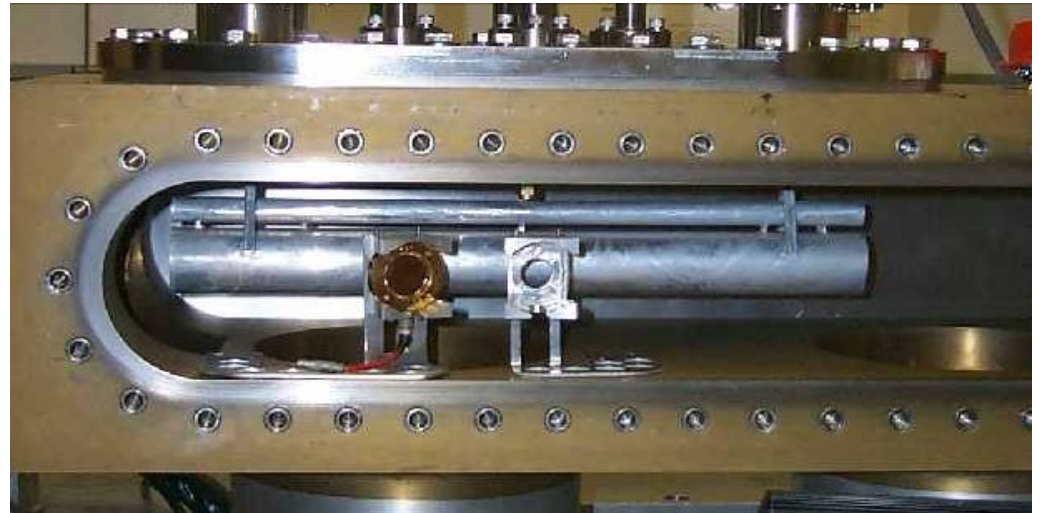
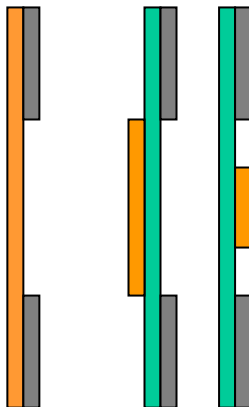

What is the target?

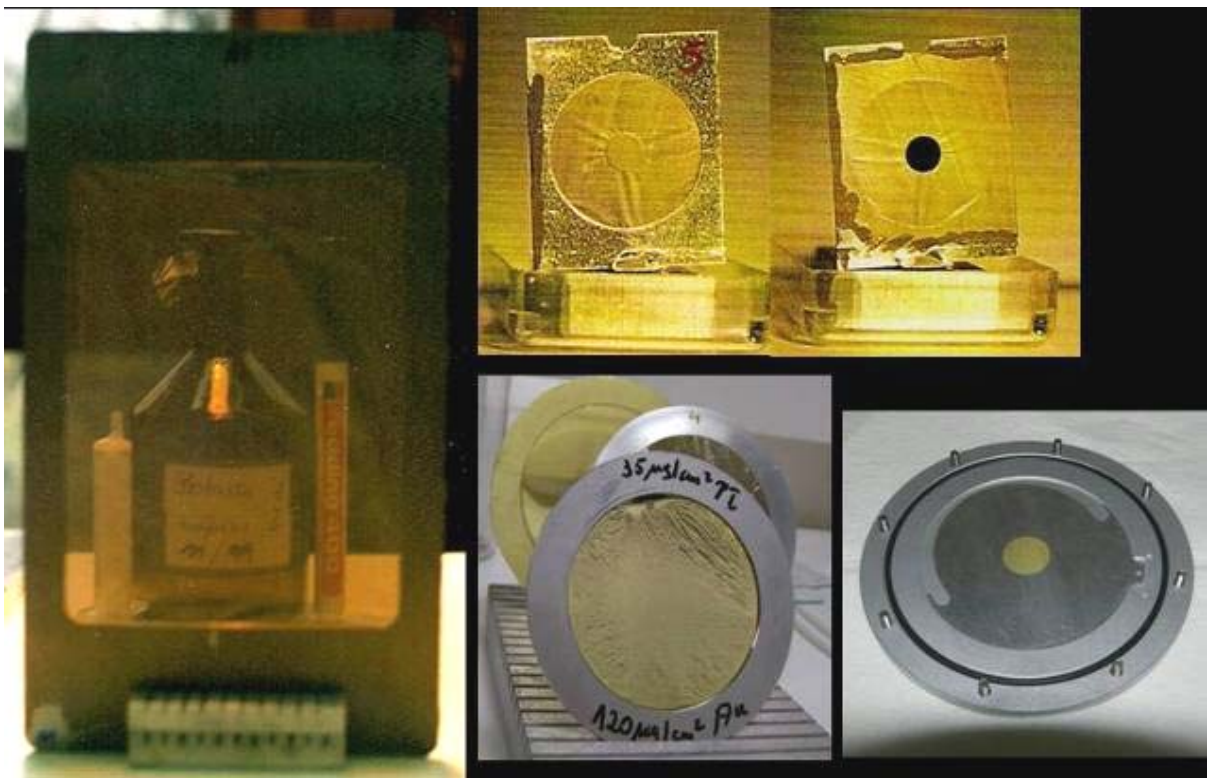

How to make the target?

The choice of the method depends on many aspects:

- target form (phase) and characteristics/parameters:
element/isotope, thickness, size
- availability of the tools/method in the target lab
- avoiding unnecessary costs
- avoiding contamination of the material

Target properties

Target material: element-isotope
and its phase: solid, liquid, gaseous

Thickness and its homogeneity

Chemical form required and available

Self-supporting or on the backing

How ???

mechanical shaping:

rolling

$0.5 \text{ mg/cm}^2 \rightarrow \text{g/cm}^2$

tablet pressing

$\sim 20 \text{ mg/cm}^2 \rightarrow \text{g/cm}^2$

sedimentation

$\sim 1-2 \text{ mg/cm}^2 \rightarrow \text{g/cm}^2$

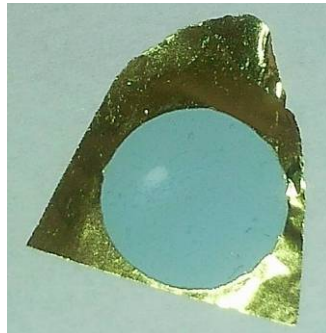
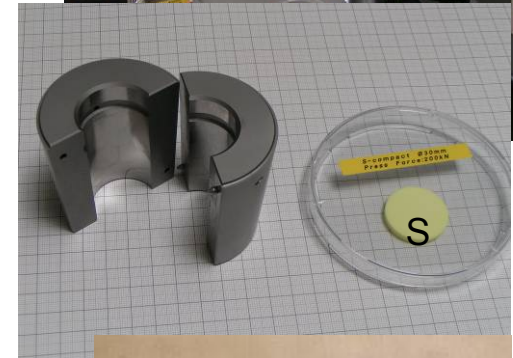
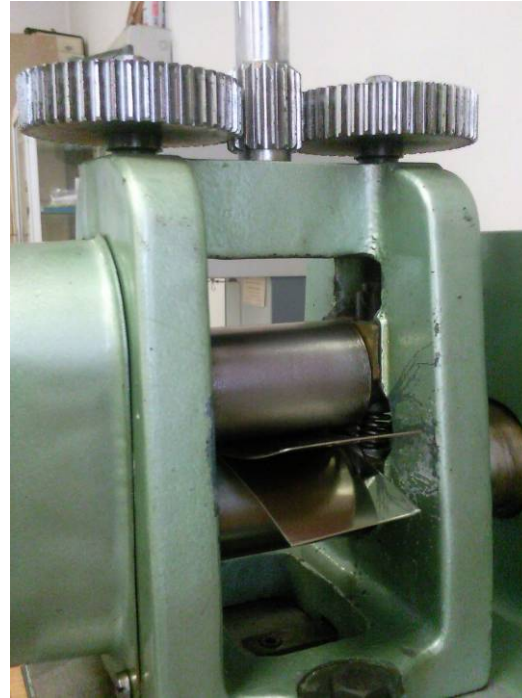

How ???

chemically: electro-deposition from hydrous or organic medium
(prepared always on the backing)



$\mu\text{g}/\text{cm}^2$ – mg/cm^2

How ???

vapour deposition in the high vacuum
(self-supporting or on the backing)

-resistance heating

-e-gun

-sputtering

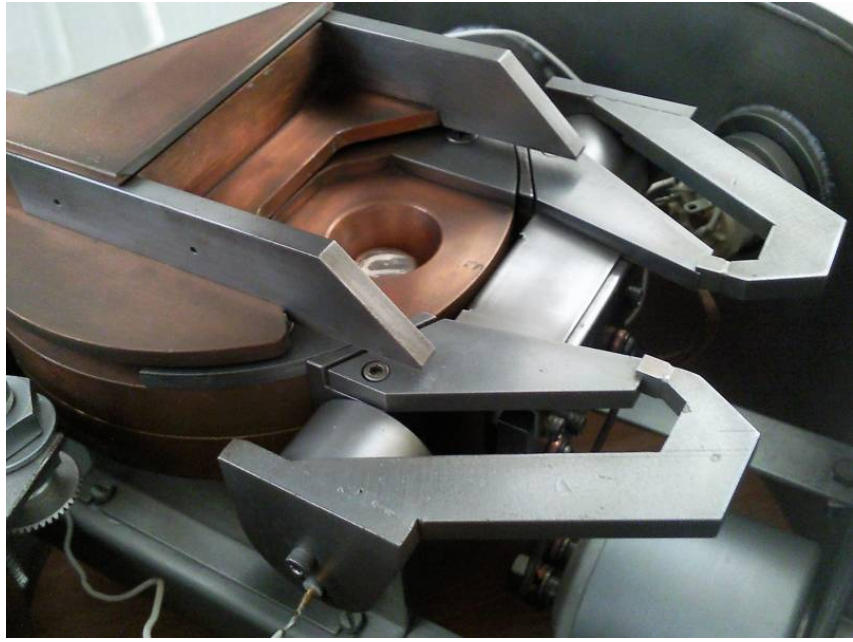
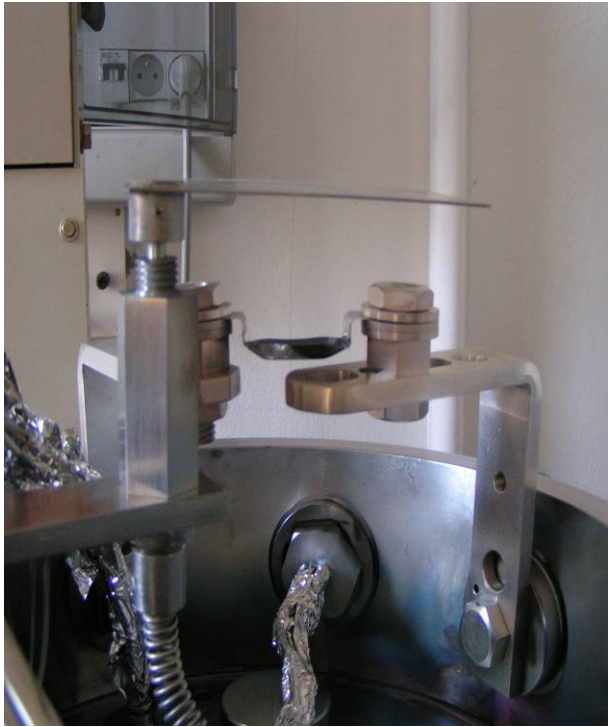
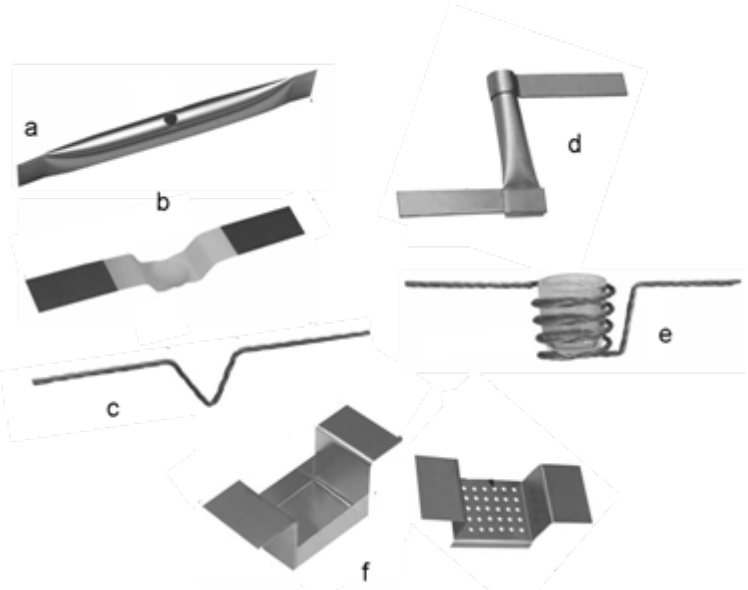

How ???



sputtering i.e. target material ejection by accelerated ions of the nobel gas



How ???

vapour deposition in the high vacuum

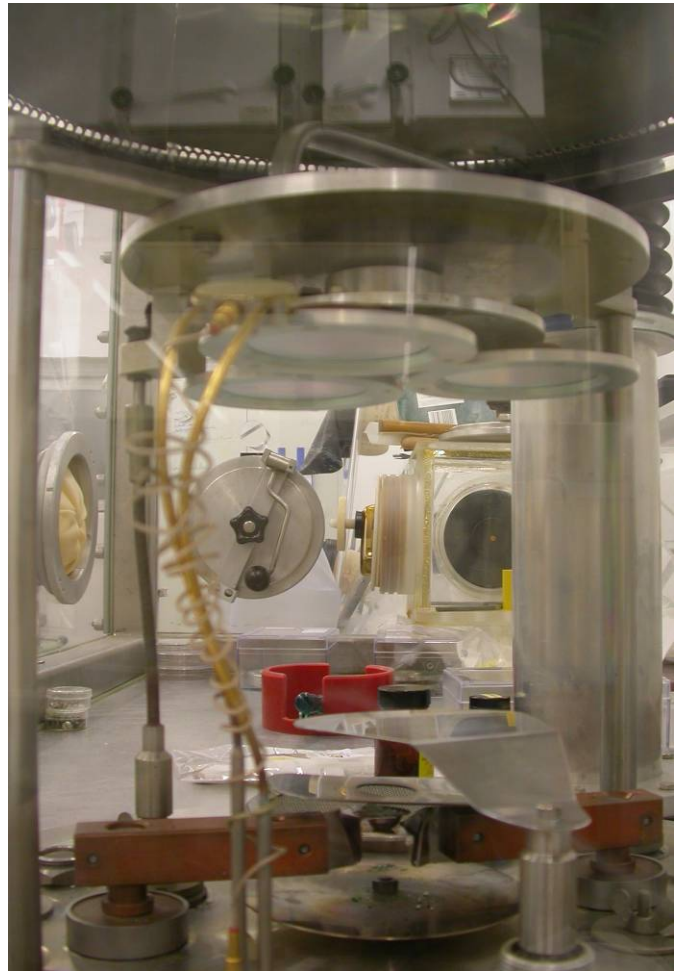
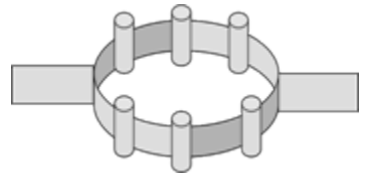
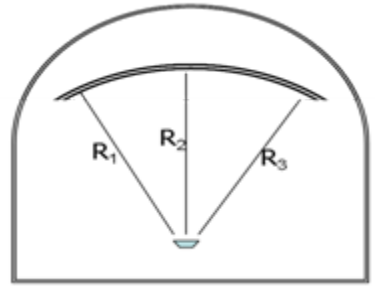
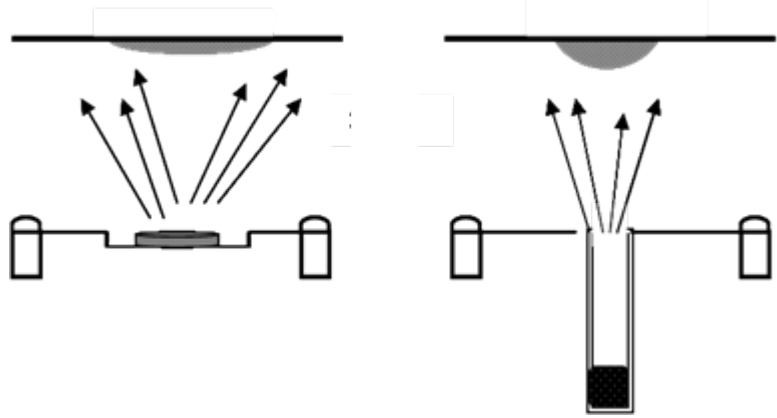

How ???

Carbon foil

- carbon arc
- laser ablation
- e-gun
- sputtering



How ???

Resistance heating

- The method is very simple, robust

but

- limited to the materials of the low melting point (not higher than 1600 -1800 °C)
- and not alloying with the boat material.

E-gun

- The method is more complex, but extremely versatile.
- Can achieve temperatures in excess of 3000°C.
- Use evaporation cones or crucibles in a water cooled copper hearth.
- Typical emission voltage is 8-10 kV.

but

- Exposes substrates to secondary electron radiation.
- X-rays can also be generated by high voltage electron beam

Sputtering

- The method can be applied to the most of the materials except those which can degrade due to ionic bombardment
- This technology allows to released the deposited material at much lower temperature than evaporation.
- gives easy film thickness control via time, allows alloy deposition, no x-ray damage

but

- requires rather big surface of the sputtered material to avoid bombarding of the cathode material.
- There is as well big chance for the impurities incorporation due to low vacuum.

Backings?

on the backing or self-supporting

backings

thin metal foils

carbon foil

plastic: Mylar, Kapton, Formvar

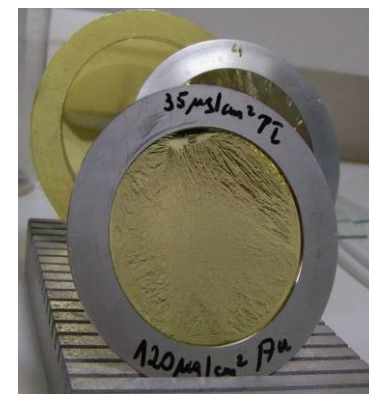

How???

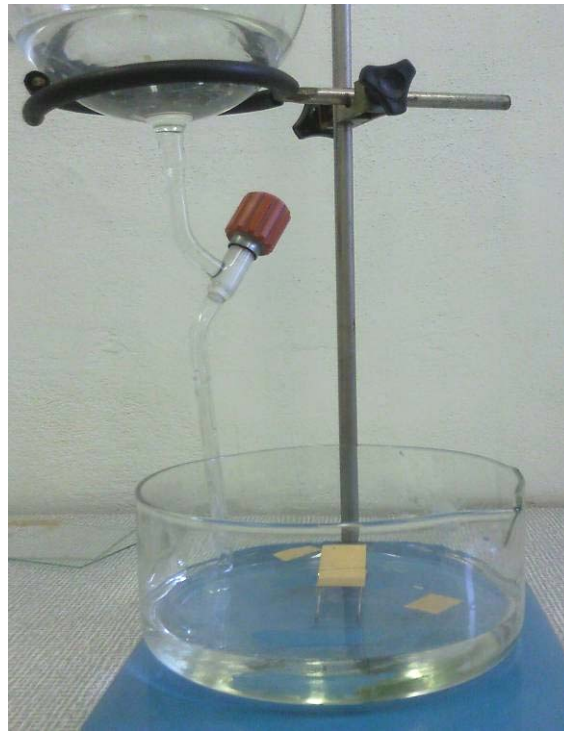

by vapour deposition
on substrate

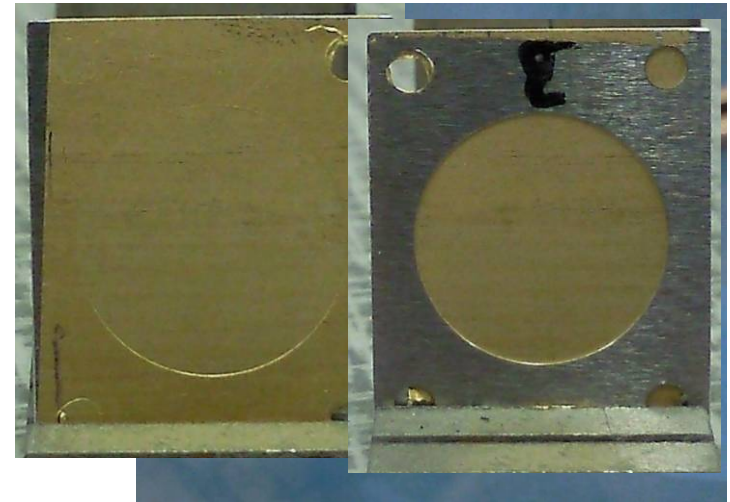

Target characterisation

Thickness:

(mass/area i.e. g-mg- $\mu\text{g}/\text{cm}^2$)



$$1 \text{ b } (\sigma) = 10^{-24} \text{ cm}^2$$

it's approx. the sectional area of the U nucleus

Number of nuclear reaction occurring in the time unit is proportional to:

- cross section (describing probability of the reaction)
- beam intensity
- number of atoms (nuclei) on the way of beam

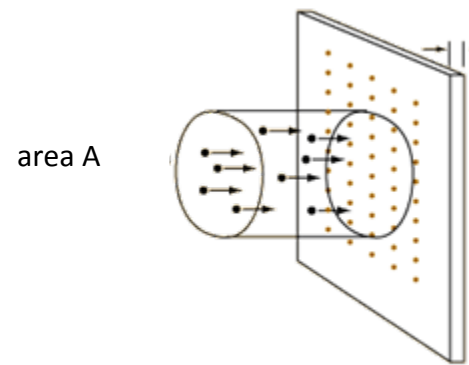

Number of nuclei/atom in the material is **proportional to the mass of sample** so it is more convenient to describe the thickness as $\text{g}\cdot\text{mg}\cdot\mu\text{g}/\text{cm}^2$ than in linear units (mm, μm).

Each mol of the material has the same number of molecules, atoms. It is known as Avogadro number

$$N = (6.02214129 \pm 0.00000027) \times 10^{23}$$

Thickness estimation: mass/area i.e. g-mg- $\mu\text{g}/\text{cm}^2$)

- * mechanically or electrically i.e. using caliper, micrometer screw or thickness gauge based on magnetic induction
- * weighing the defined area
- * in-situ during the vapour deposition process using the quartz microbalance
- * spectrophotometrically
- * measurement of the α particles or X-ray energy
- * profilometers working in a contact or non-contact modes

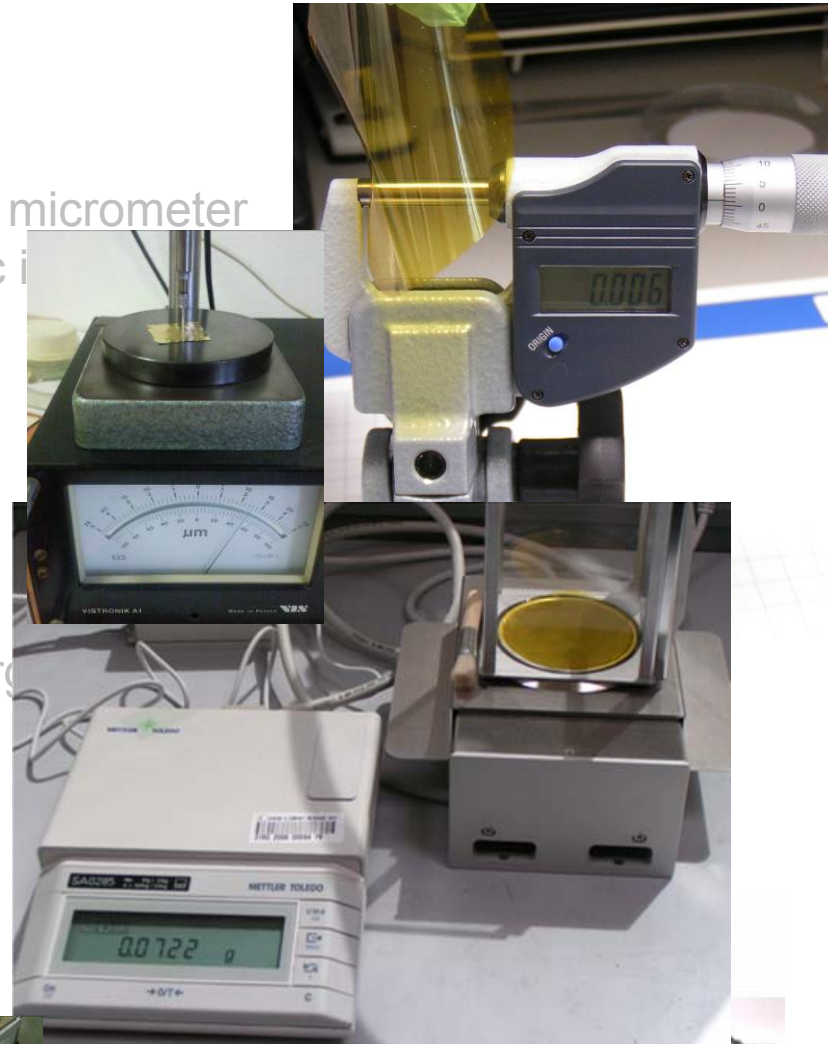

Thickness estimation of the radioactive targets:

if made by evaporation: during preparation process with quartz microbalance

ready target: measurements of the radioactivity

thickness homogeneity by radioactivity scan across the target area

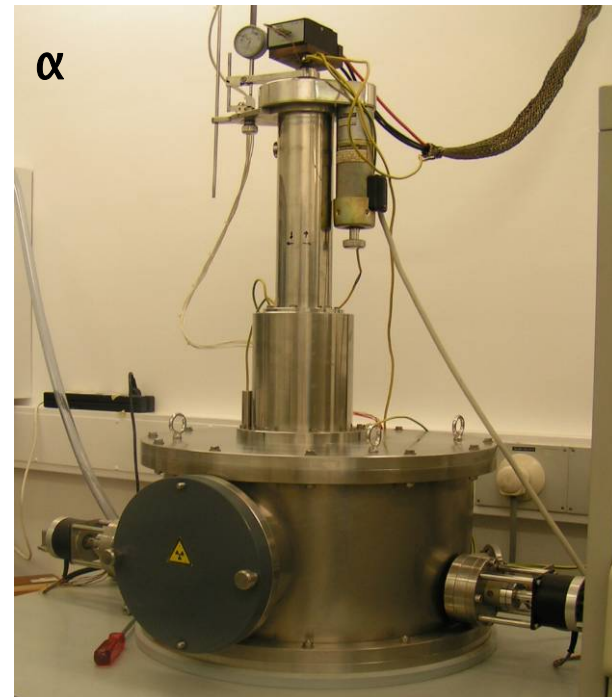

Target characterisation

Thickness: (mass/area i.e. g-mg- $\mu\text{g}/\text{cm}^2$)

Thickness homogeneity:

?

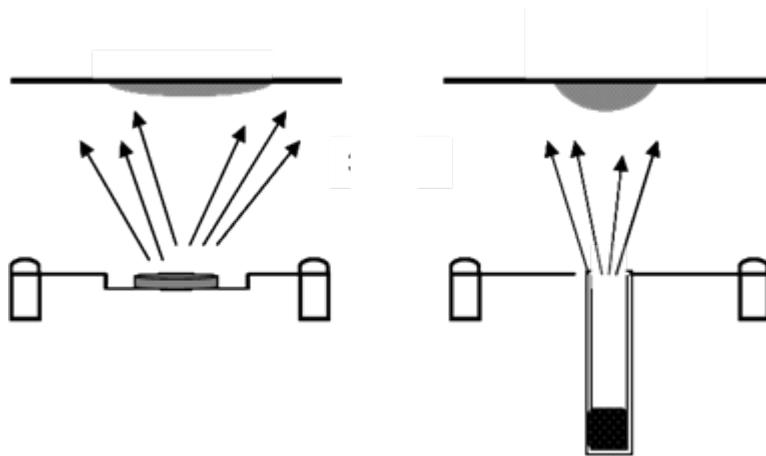

Surface characterisation

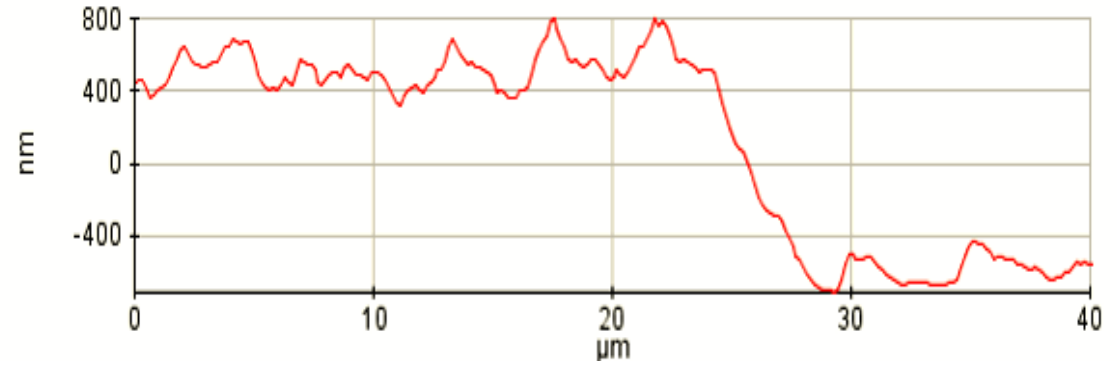
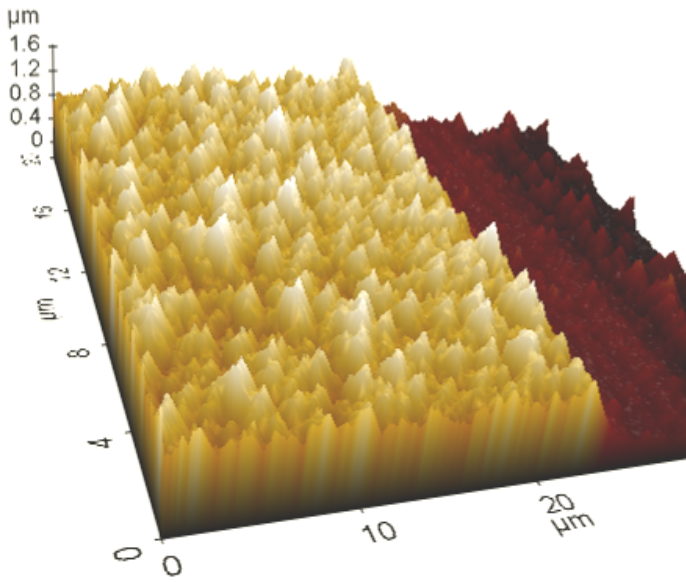

AFM images of tristearin layer

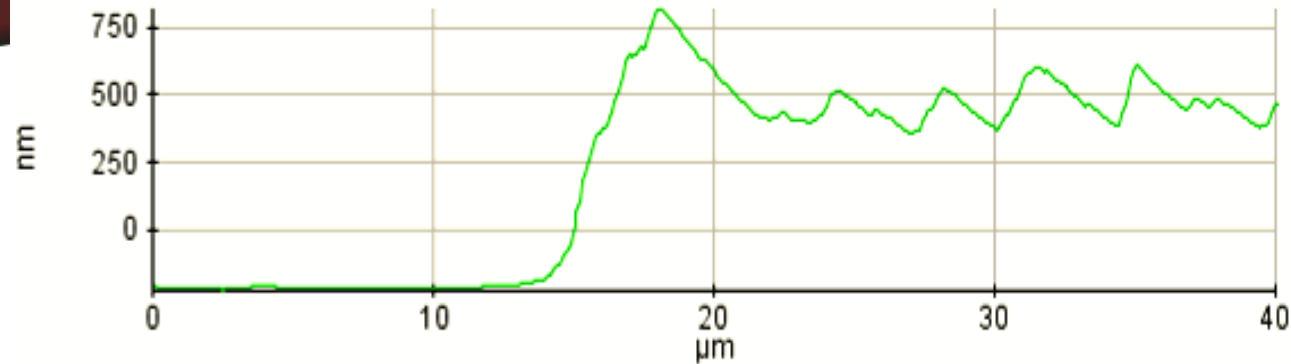
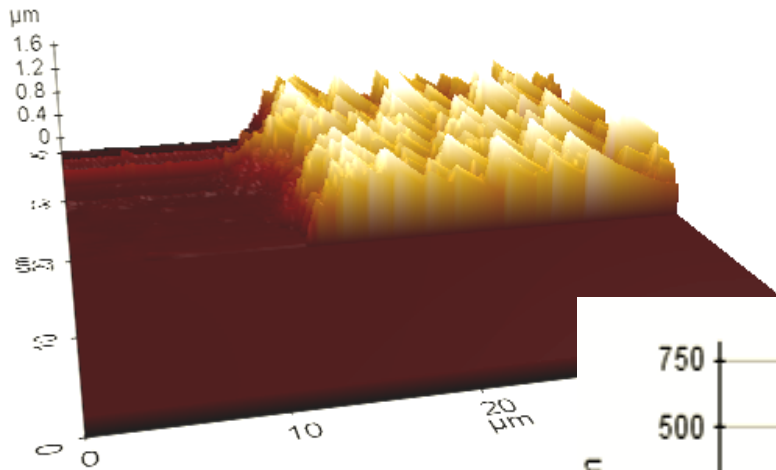

Target characterisation

Thickness: (mass/area i.e. g-mg- $\mu\text{g}/\text{cm}^2$)

Thickness homogeneity (including surface topography)

Purity/composition

Purity/composition

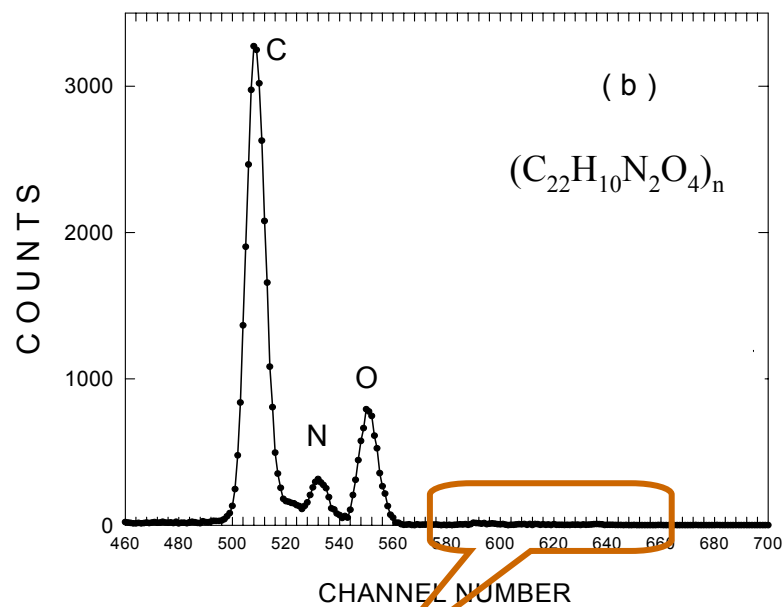
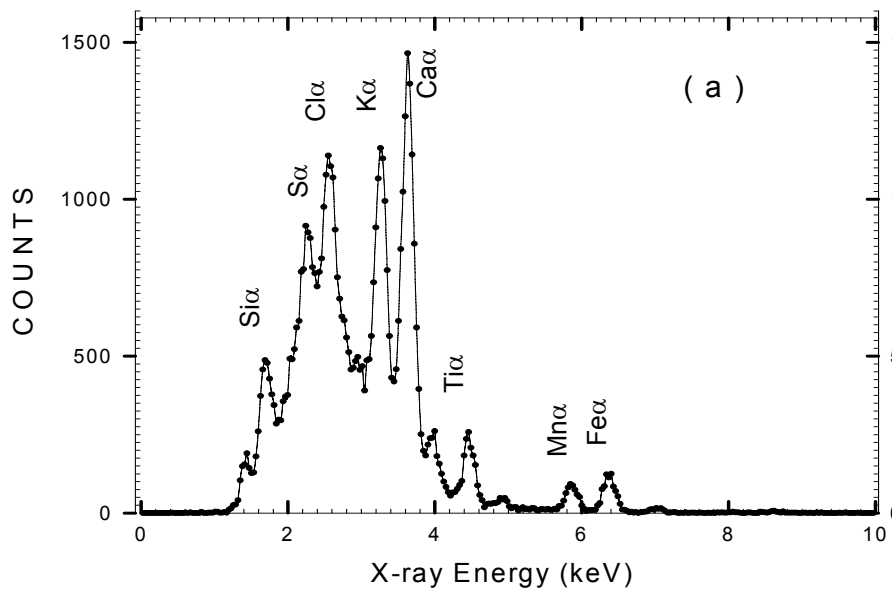

PIXE spectrum of polyimide foil

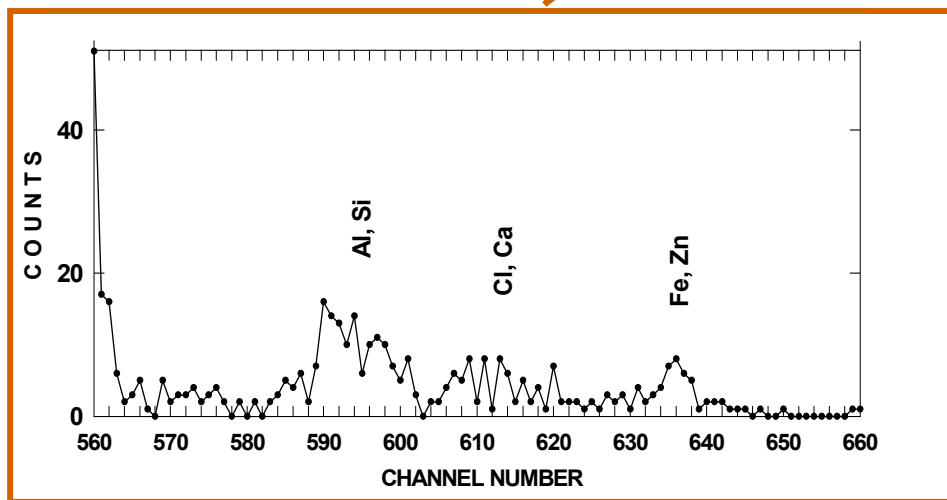

Purity/composition

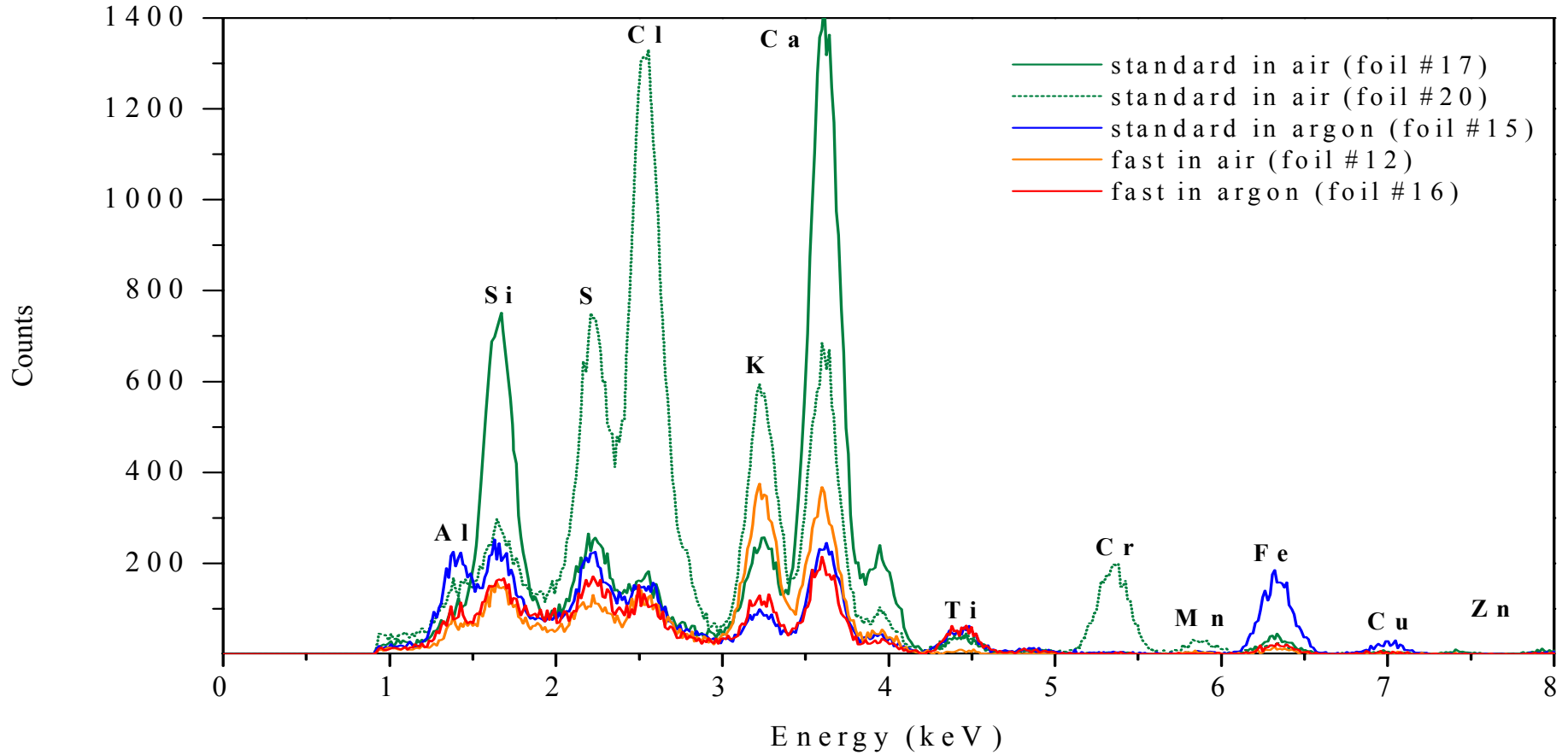

heat dissipation

heat dissipation

$$W = \Delta E \times I$$

deposited in the target by the beam:
conduction + radiation + convection

by conduction

$$q = k A dT / s$$

where

A = heat transfer area (m²)

k = thermal conductivity of the target (W/(m K))

dT = temp. difference (K)

s = distance from beam spot to the cold area (m)

by radiation

$$q = \varepsilon \sigma T^4 A$$

where

A – radiation area [m²]

ε - thermal emissivity

σ - Stefana-Boltzmana constant [W m⁻²K⁻⁴]

T temp. difference [K]

Thermal impact can be decreased by

- using ‘target wheel’
- ‘applying so called beam wobbling



targets mounted on the
wheel for TASCA project
Transactinide Separator and
Chemistry Apparatus

Closing advices

When ordering a target define the characteristic needed/significant for planned studies but avoid exaggeration i.e. do not order a target with much better characteristic than really needed. This may cause additional costs and/or ... delay.

element/isotope

thickness, dimensions

*supported or not, if yes what can be considered as support
purity*

Do not overestimate the importance of the chemical form of the target material.

not always have to be a pure elemental form, the compounds may suite your needs as well but often it is much easier (cheaper) to make the target from compound

Discuss with target maker your planned target. Target preparation people can do sometimes more for you than you believe; it is often a question of communication and of raising the relevant problems/aspects.



target bibliography index by *International Nuclear Target Development Society*
www.intds.org

25 x 25 cm of 9 $\mu\text{g}/\text{cm}^2$ of Al

